

---

# Simulation democratization

## Model Order Reduction

# Democratization of simulation

CAE Expert

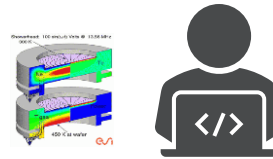

CAD Design Engineer  
*Design & Process optimization*

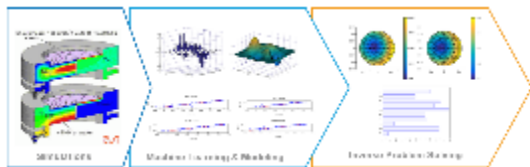

Control Engineer  
*Real-time process control*



Technician  
*Simulation democratization*



\*CAE = Computer Aided Engineering  
\*\*CAD = Computer Aided Design

# Example: Process Industry

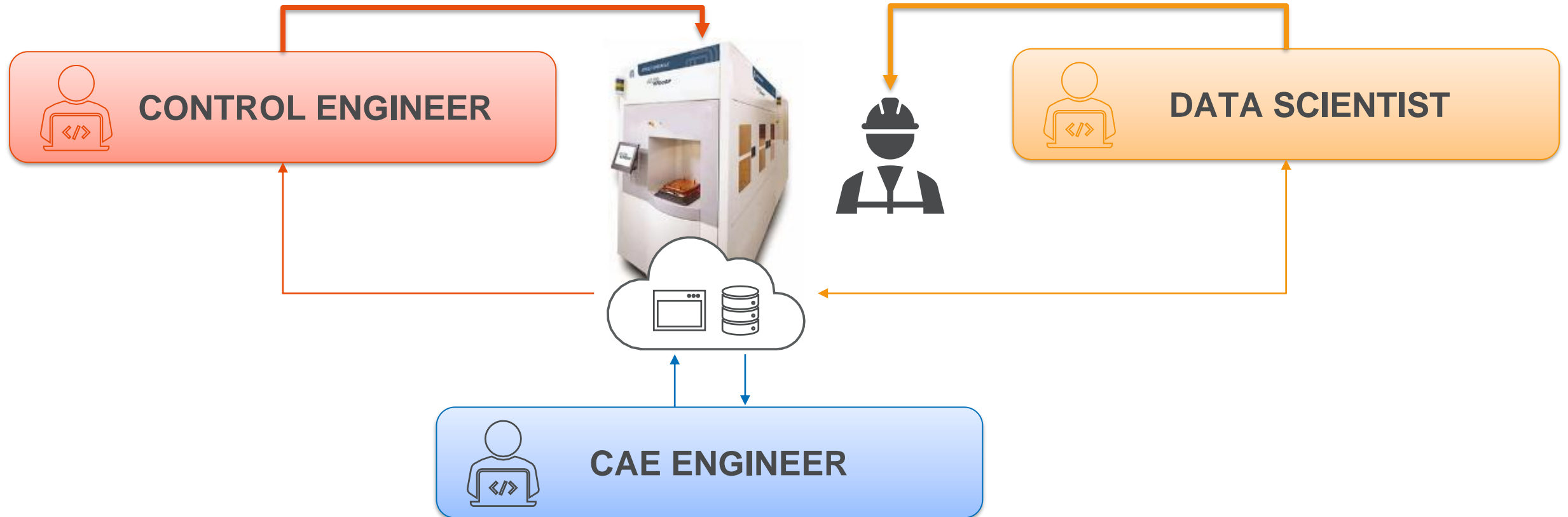



# CAE ENGINEER

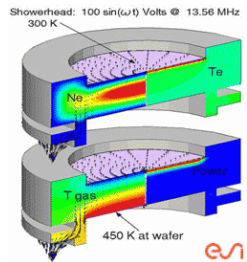

SIMULATION

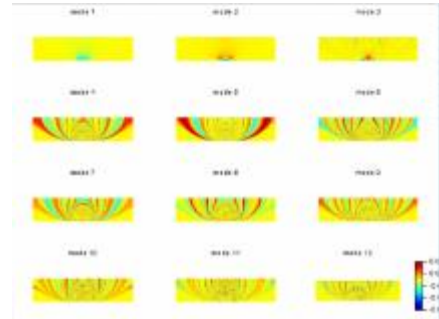

MODEL ORDER REDUCTION



MODEL CALIBRATION



ePOD/FMU

MODEL DEPLOYMENT





# CONTROL ENGINEER

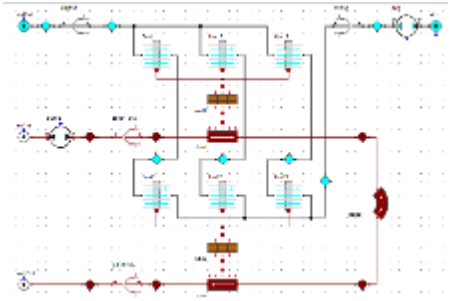

**FULL SYSTEM MODEL**



**FMU**

**DETAILED COMPONENT MODEL**



**CONTROL SYSTEM DESIGN**



**C CODE GENERATION**

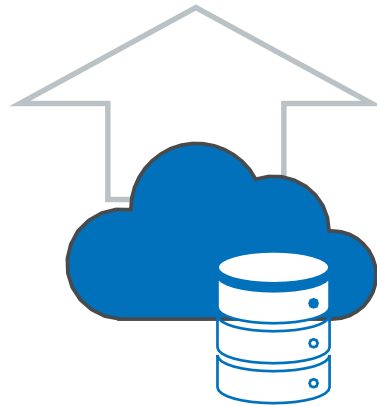



# DATA SCIENTIST

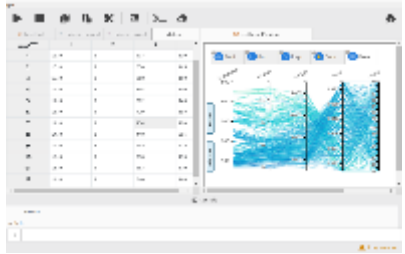

**EXPERIMENTAL DATA  
PROCESSING**



ePOD

**REAL TIME SIMULATION**

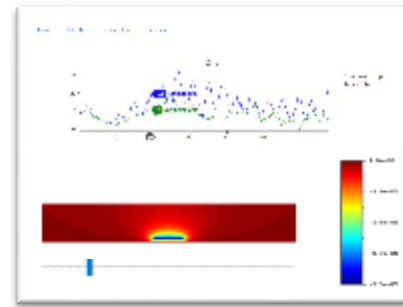

**DECISION SUPPORT  
APPLICATION DESIGN**



**CLOUD DEPLOYMENT &  
REMOTE VISUALIZATION**

